

SKU: 221.43031

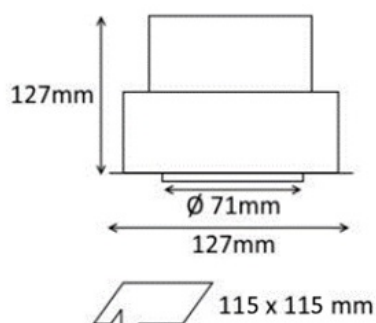

Light Colour	Neutral White
Power Rating (W)	30
Light Angle	Flood
Beam Angle	24
Colour (Body)	Black
Lumens	3150
Tension (V)	100-250
CRI	90
IP	20
Lumen maintenance (hour)	40000
Inclination Angle	30
Rotation Angle	355
MacAdam Step	3
Zhaga	Y
Double Insulation	Y
Glass	Y
Dimmable	Y
Projector Measurement (mm)	127x127
Projector Weight (kg)	0.8
Projector Box Size (mm)	140x140x155

PRODUCT DESCRIPTION

Ceiling-recessed luminaire with aluminum body. Elegant squared design with thin bezel, built-in snoot (for low glare) and orientable LED engine.
Special body colour, light colour or power available under request.

[print_product id="PRODUCT_ID" mode="pdf" show_icon="no" text="DataSheet Product PDF"]

[Energetic certificate - EPREL](#)

[Declaration of Conformity](#)