

SKU: 424.32011

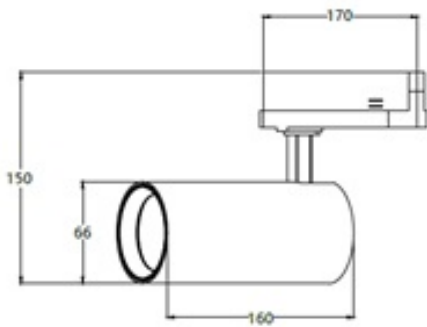

Light Colour	Warm White
Power Rating (W)	20
Light Angle	Spot
Beam Angle	15
Colour (Body)	Black
Tension (V)	100-250
CRI	90
IP	20
Lumen maintenance (hour)	40000
Inclination Angle	90
Rotation Angle	355
MacAdam Step	3
Zhaga	N
Double Insulation	Y
Cross	N
Barn Door	N
Honeycomb Louver	N
Miro Reflector	N
Wall Washer	N
Snoot	N
Glass	Y
Dimmable	N
Projector Measurement (mm)	Ø66x160
Projector Weight (kg)	0.7
Projector Box Size (mm)	200x183x80
Efficiency	115.836
Energy Class	E

PRODUCT DESCRIPTION

20W track led projector with passive cooler, in aluminium die casting trim can be white or black (other colour under request).

Slick design hides the heat sink the cylindrical head for better looking luminaire, and the power supply in the track adapter for a smaller projector head.

The head can be directed in 360° in the horizontal axis and 180° in the vertical axis.

Reflector Made of 99.98% Aluminium and front ring made of high temperature resistant PC material.

LED Module mounting hole dimension meets the standard of zhaga.

[print_product id="PRODUCT_ID" mode="pdf" show_icon="no" text="DataSheet Product PDF"]

[Energetic certificate - EPREL](#)

[Declaration of Conformity](#)