

**SKU:** 424.32531

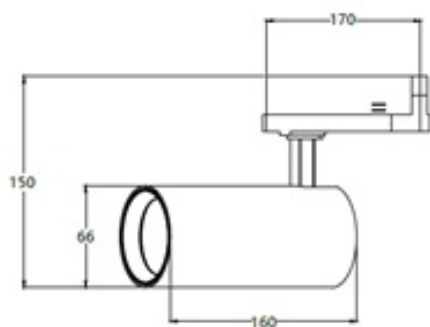

<b>Light Colour</b>	Warm White
<b>Power Rating (W)</b>	25
<b>Light Angle</b>	Flood
<b>Beam Angle</b>	36
<b>Colour (Body)</b>	Black
<b>Tension (V)</b>	100-250
<b>CRI</b>	90
<b>IP</b>	20
<b>Lumen maintenance (hour)</b>	40000
<b>Inclination Angle</b>	90
<b>Rotation Angle</b>	355
<b>MacAdam Step</b>	3
<b>Zhaga</b>	N
<b>Double Insulation</b>	Y
<b>Cross</b>	N
<b>Barn Door</b>	N
<b>Honeycomb Louver</b>	N
<b>Miro Reflector</b>	N
<b>Wall Washer</b>	N
<b>Snoot</b>	N
<b>Glass</b>	Y
<b>Dimmable</b>	N
<b>Projector Measurement (mm)</b>	Ø66x160
<b>Projector Weight (kg)</b>	0.7
<b>Projector Box Size (mm)</b>	200x183x80
<b>Efficiency</b>	115.248
<b>Energy Class</b>	E

#### **PRODUCT DESCRIPTION**

25W track led projector with passive cooler, in aluminium die casting trim can be white or black (other colour under request).

Slick design hides the heat sink the cylindrical head for better looking luminaire, and the power supply in the track adapter for a smaller projector head.

The head can be directed in 360° in the horizontal axis and 180° in the vertical axis.

Reflector Made of 99.98% Aluminium and front ring made of high temperature resistant PC material.

LED Module mounting hole dimension meets the standard of zhaga.

[print\_product id="PRODUCT\_ID" mode="pdf" show\_icon="no" text="DataSheet Product PDF"]

[Energetic certificate - EPREL](#)

[Declaration of Conformity](#)